

COIN BAR STOOL



SPECIFICATION SHEET



DESCRIPTION

A decorative metal 6mm coin footplate gives this diminutive bar stool personality and heft. Choose from our standard designs or specify your own. Shown here in solid American black walnut with chocolate satin finish and cognac saddle leather with nickel, polished brass and patinated brass coins.

Built by hand in England.

DIMENSIONS

Height	775mm
Ø	350mm

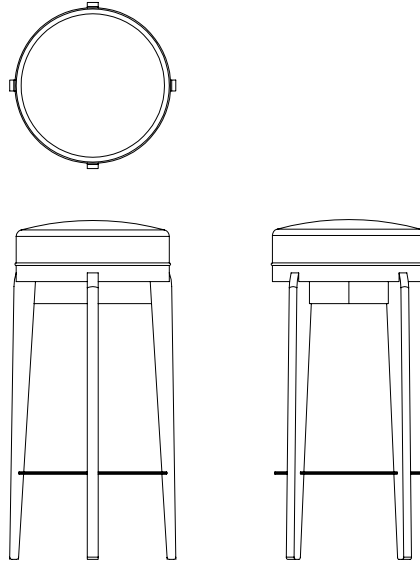

TIMBER FINISHES



DIMENSIONS

Height	940mm
Width	400mm
Depth	465mm
Seat Height	750mm

NOTES

- Some finishes may carry an up-charge.
- Non-standard finishes and sizes are available, up-charges may apply.
- Standard lead-time is 8 – 14 weeks.
- Finishes are shown for illustrative purposes only. Samples are available from the showroom.

METAL FINISHES



CARE INSTRUCTIONS

Our furniture has been made to age & patina naturally over time. Simple maintenance will help it to age gracefully. Please read our suggestions below to help to insure that your furniture remains beautiful:

CLEANING & MAINTENANCE GENERAL GUIDELINES

A weekly clean with a lightly dampened, non-abrasive cloth is recommended to keep the furniture clean & to remove household dust. We do not recommend the use household polish or spirit-based cleaners as these may cause damage. Keep your cleaning regime simple, if you are unsure contact us for further advice.

NOTES REGARDING HARDWOOD

Whilst every effort is made to source well-seasoned timbers, it is inevitable that some wood movement will occur. All natural timbers, particularly hardwoods contain moisture. When this moisture level drops e.g. during long hot dry spells of weather or when the timber is subject to extremes in relative humidity you may find the timber will move very slightly or crack. This is absolutely normal & in many ways adds to the beauty of the product. To prevent your furniture from drying out over long periods of time the use of a small amount of beeswax is recommended periodically. Amy Somerville LTD can advise you on what products are appropriate.

NOTES REGARDING LEATHER

Whilst every effort is made to source hides of the highest quality, leathers are a natural product and will inherently have some marks & scars present as part of their natural characteristics. Leather is resilient & will patina with age. It is not demanding & requires very little care. It should not be abused with harsh cleaners or substances such as wax or mink oils, saddle soap or other leather polishes. These become surface sealants, which keep premium full grain leathers from breathing (hence they will eventually dry out & crack). A periodic wipe with a cool damp cloth is sufficient means of cleaning under normal conditions. Please note that certain inks or stains cannot be removed from leather just as they cannot be removed from other upholstery fabrics. Amy Somerville LTD can offer advice on where to obtain Maintenance Kits, & specially formulated cleaners, conditioners & ink removers.

NOTES REGARDING METALS & CAST METALS

All metals will naturally patina over time. Any smudges such as fingerprints or wear can be eliminated using a soft lint-free cloth & "Peek" metal polish. Mild scratches can also be softened in the same way. To maintain the high reflective shine of cast metal we recommend applying "Renaissance" micro-crystalline wax polish to the piece, then buffing & polishing with a soft lint-free cloth.